

Lithium Ion Battery

Discover Advanced Energy (AES) batteries allow for equipment design and functionality improvements and deliver productivity gains through enhanced cycling, charge time and weight reductions in stationary and mobile applications. Dramatic improvements in cycle life and charge efficiency combined with zero maintenance requirements provide the end user with significant cost of ownership savings.

MECHANICAL DRAWINGS

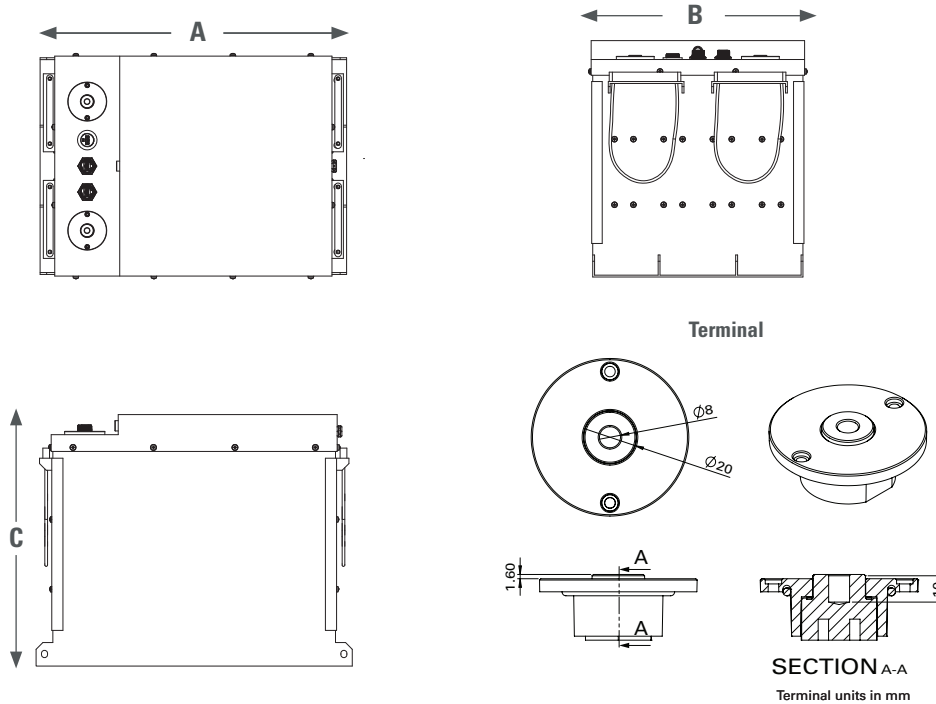

MECHANICAL SPECIFICATIONS

Length (A)	471.5 mm	18.5 in
Width (B)	347.5 mm	13.7 in
Height (C)	375 mm	14.7 in
Weight	87 kg	192 lb
Terminal	M8	
Terminal Torque	9 Nm +/- 3	6.64ft-lb
Case Material	Steel	
IP Rating	IP 55	

ELECTRICAL SPECIFICATIONS

Cell Chemistry	LiFePO ₄	
Cell Modules	16S 26P	
Charge Temperature	0°C / 45°C	32°F / 113°F
Discharge Temperature	-20°C / 50°C	-4°F / 122°F
Storage Temperature	-20°C / 45°C	-4°F / 113°F
Self-Discharge 25°C / 77°F	< 3% per month (battery off)	

CAUTION: Extra considerations must be given to depths of discharge, operating voltages and currents when designing systems for use at maximum operating temperatures.

ELECTRICAL SPECIFICATIONS

Nominal Voltage	51.2 V
Charge Voltage	54.4 V
Maximum Voltage*	58.4 V
Minimum Voltage	44.8 V
Nominal Capacity (1C)	130 Ah
Nominal Energy (1C)	6656 Wh
Max Continuous Current	130 A
Peak Current	600 A for 3 seconds

Electrical Specifications at 25°C.
* Do not exceed maximum voltage at the battery terminals.

Constant Power - Minutes of Discharge			
500 W	1000 W	2000 W	3000 W
799	399	200	133
Constant Current - Minutes of Discharge			
@10A	@25A	@50A	@100A
780	312	156	78



Do not mix with lead acid batteries when recycling.

BENEFITS & FEATURES

Efficient & Fast Charging

Discover AES batteries are 15% more efficient than lead acid batteries, allowing for reduced charge times and greater utilization of renewable energy sources.

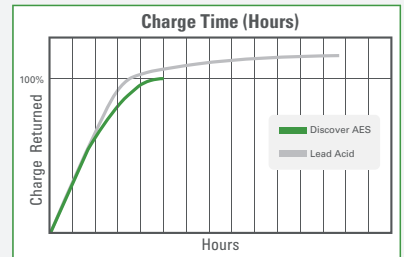

Efficient and Stable Discharge

Deliver > 95% of their capacity at high and stable voltages, increasing equipment performance and reducing motor fatigue.

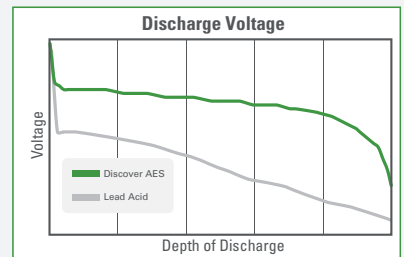

Partial State of Charge (SOC)

Discover AES batteries will not suffer negative effects from partial SOC.

Weight Efficient

Systems are 1/3 the weight of their lead acid battery equivalent.

Battery Management System

Integrated Battery Management System to prevent abuse outside of current, voltage and temperature limits.

Renewable System Ready

Xanbus commport provides plug and play integration with SE Conext XW+, SW, SCP, ComBox and Solar Charge Controllers.

SAFETY AND PERFORMANCE CERTIFIED

- IEC 62133
- UL 2271 (pending)
- UL 1973
- UN 38.3

SHIPPING CLASSIFICATION

- UN 3480, Class 9 (Lithium ion batteries)

FUNCTIONAL SAFETY



UN38.3 PASSED
TRANSPORT SAFETY CERTIFIED

NOTE 1^Δ:

Qualification is a hand shaking procedure that allows a charger to wake up an auto-on equipped AES battery. Qualification is an optional feature and not required for standard charging.

CAUTION[◊]:

Extra considerations must be given to depths of discharge, operating voltages and currents when designing systems for use at maximum operating temperatures.

VOLTAGE REGULATED IU CHARGING CURVE ^Δ

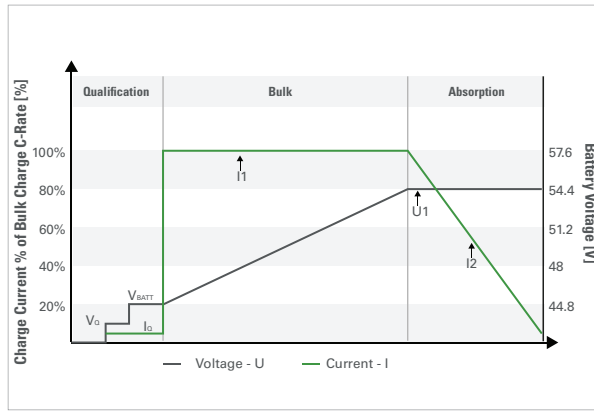

VOLTAGE REGULATED IU CHARGING CURVE PARAMETERS

Nominal Voltage	48 V
Qualification Voltage (V_0^*)	Min 12 V / Max 48 V ($I_0 < 1$ A)
Battery Voltage (V_{BATT})	≥ 40 V
Bulk Current ($I1$)	65 A recommended 130 A maximum
Absorption Voltage ($U1$)	54.4 V
Termination Charge Current	$I2 \leq 2$ A

*Qualification is optional to utilize auto-on feature

VOLTAGE IN RELATION TO THE STATE OF CHARGE (SOC)

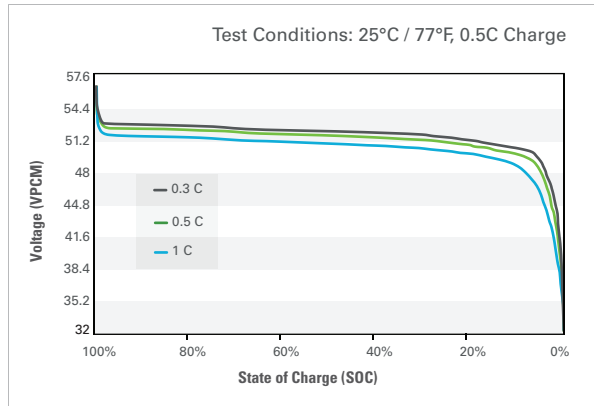

DISCHARGE VOLTAGE IN RELATION TO THE TEMPERATURE

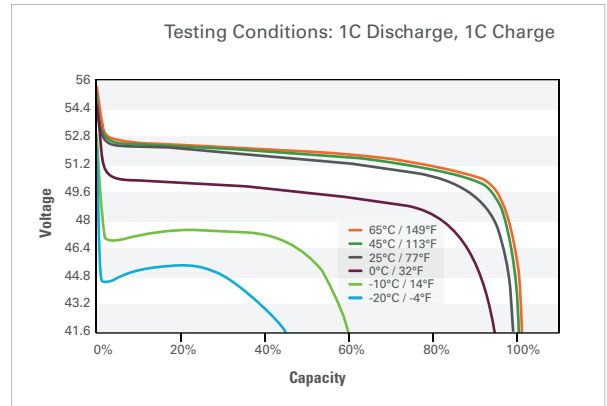

THERMAL DERATING CURVE (CURRENT) [◊]

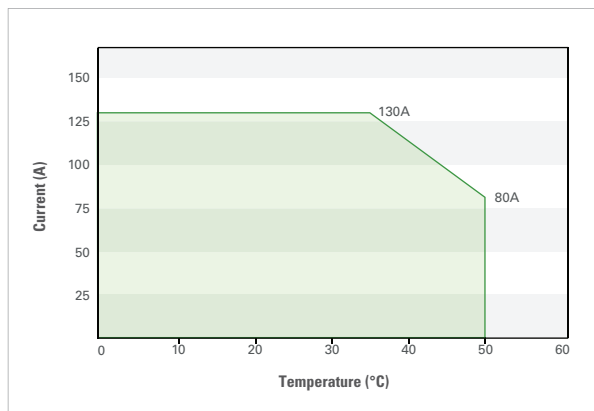

CAUTION:

Direct connection to DC motors without proper safety protection, motor controllers, and external motor voltage clamping systems (such as high power anti-parallel diodes or braking resistor systems) may result in damage to the internal pack protection system which may result in unsafe situations. Please consult Discover technical support before directly connecting any motor loads.

Discover Energy Corp. attempts to ensure the correctness of the product description and data contained herein. We reserve the right to change designs, specifications and pricing at any time without notice or obligation. It is the responsibility of the reader of this information to verify any and all information presented herein.